



Go Smart!

Smart teknologi

Hvordan kan du ta i bruk smarte kontrollventiler?

Ved produksjef VA, Kristian Drolsum

Agenda

- Dagens teknologi
- Smarte kontrollventiler
- Montering, vedlikehold og kalibrering
- Enkel styring og overvåkning
- Brann og sikkerhet
- Effektivt og økonomisk
- Spørsmål



DAGENS TEKNOLOGI



| Analoge telefoner, hvorfor slutta vi å bruke disse?



**| 90-tallets mobiltelefoner – de ble veldig bra.
Hvorfor bruker vi de ikke lengre?**



| Smarttelefonen tok over



| Analoge kontrollventiler



PLS (Programmerbar Logisk Styring)



SMARTE KONTROLLVENTILER



Smarte kontrollventiler



| En ventil erstatter alle varianter pilotstyrte

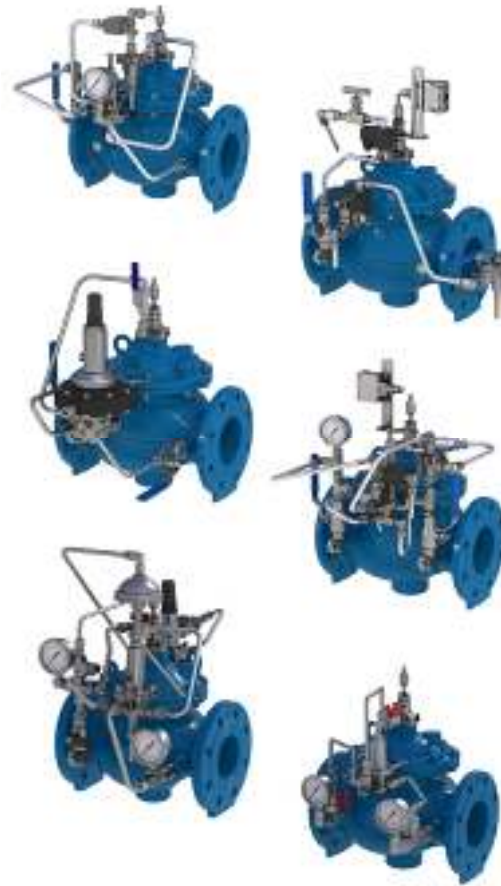

En ventil erstatter alle varianter pilotstyrte

Kontrollrom



Applikasjon



Sensorer

System

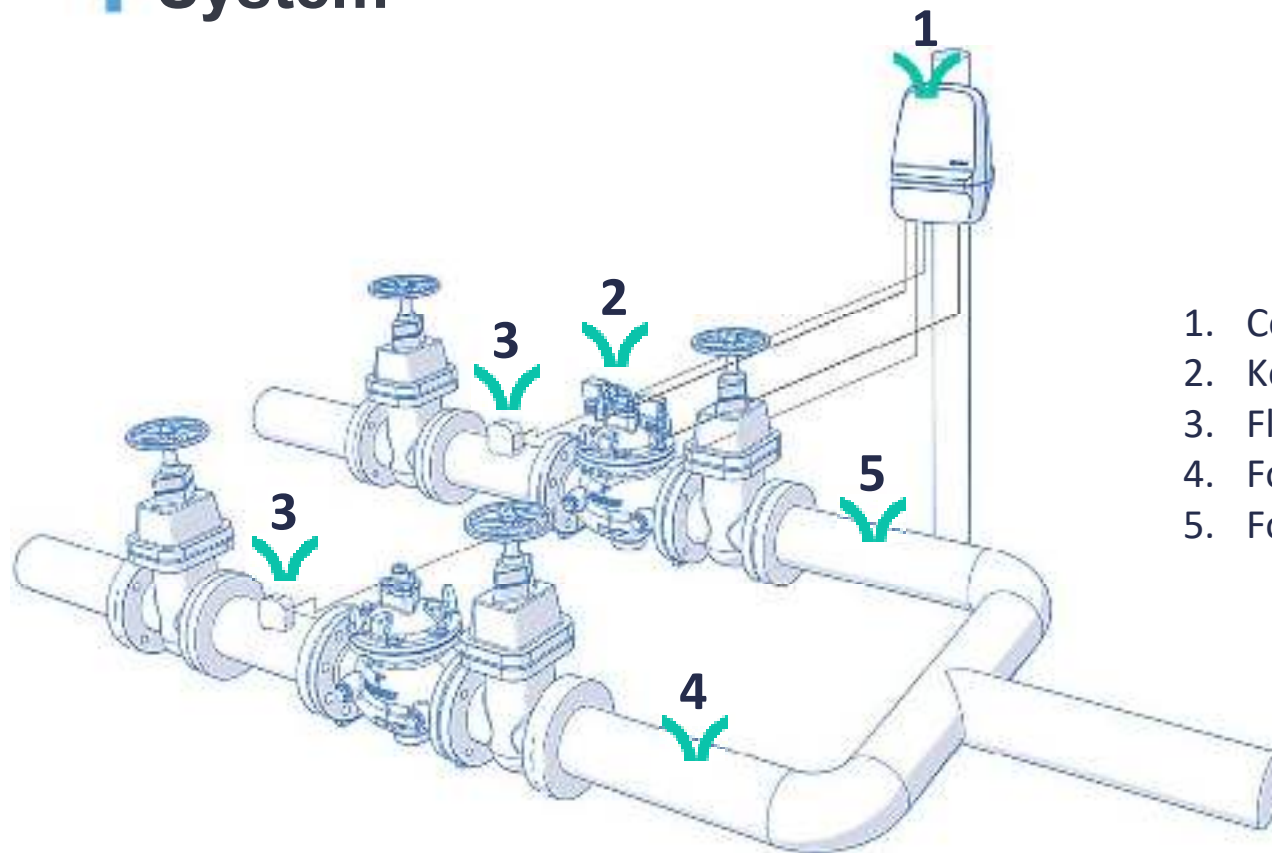

1. Condor
2. Kontrollventiler
3. Flow meter
4. Forsyningslinje 1
5. Forsyningslinje 2

MONTERING, KALIBRERING OG VEDLIKEHOLD



| Enkel oppkobling mot magnet ventiler

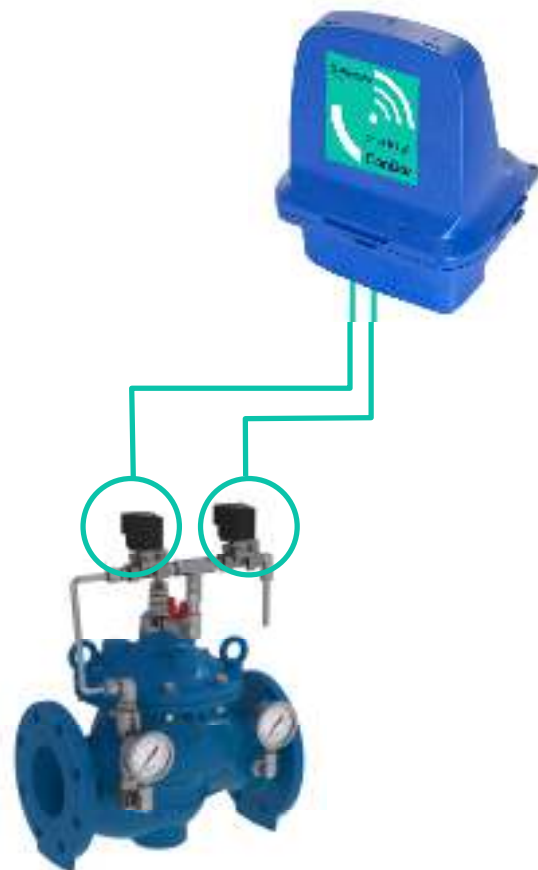

Enkel oppkobling mot styringstrøm eller lite solcelle panel (eller annen kilde)



I Integreert back-up batteri

2 – 3 dagers drift ved bortfall av energi (ved aktiv regulering)

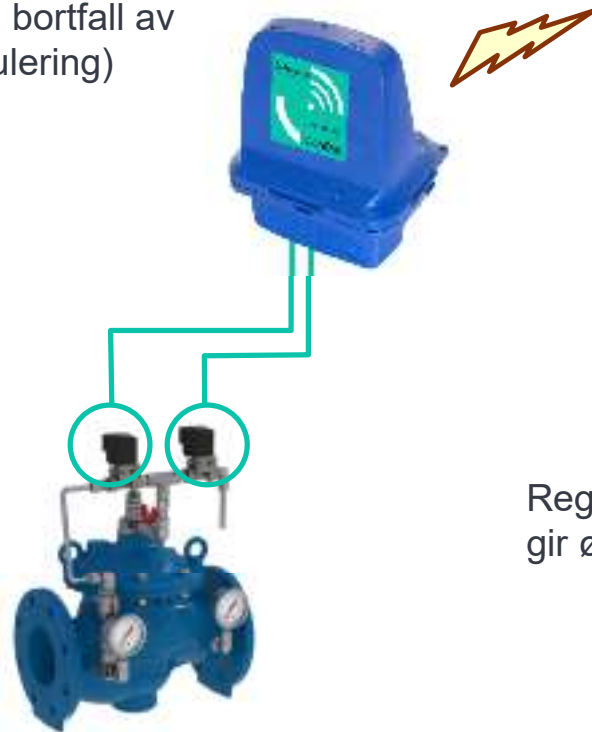

Reguleringsventilen holder posisjon eller gir ønsket aktivering etter dette.

| Sensorer

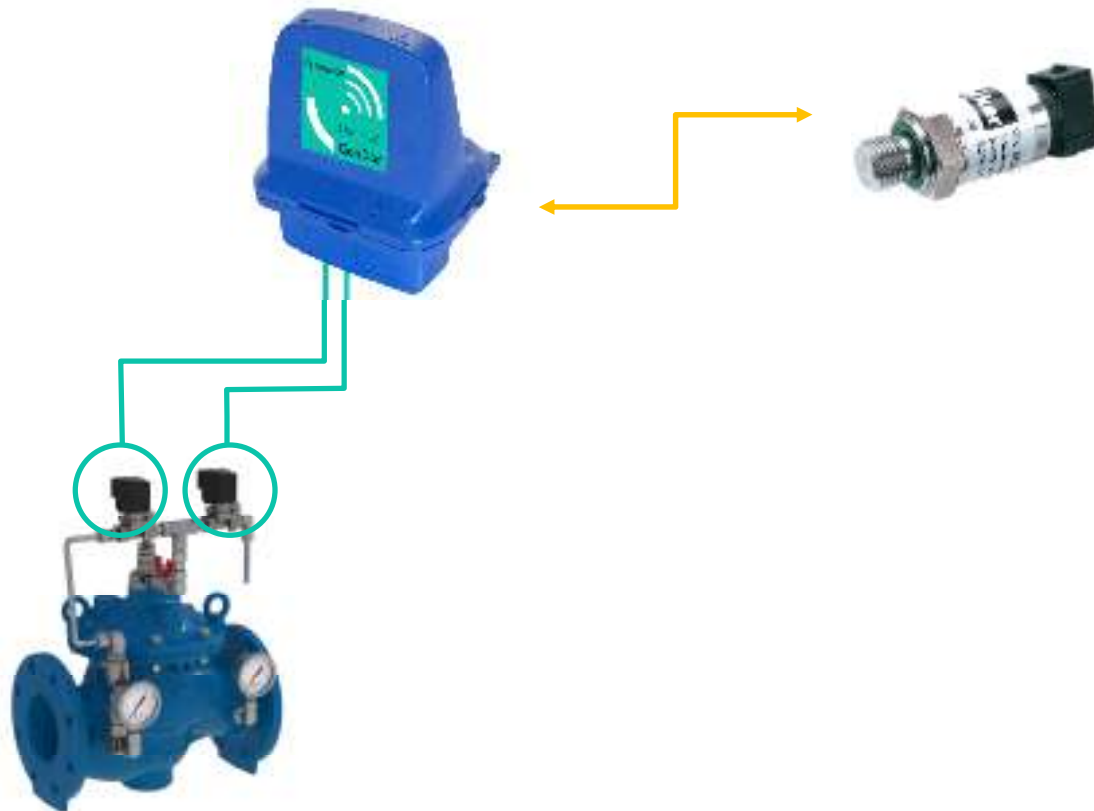

ENKEL STYRING OG OVERVÅKNING



Kablet

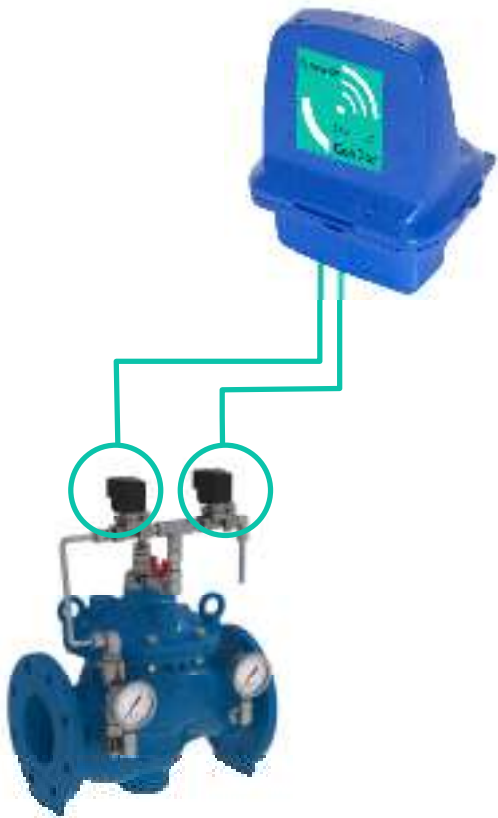

Bluetooth

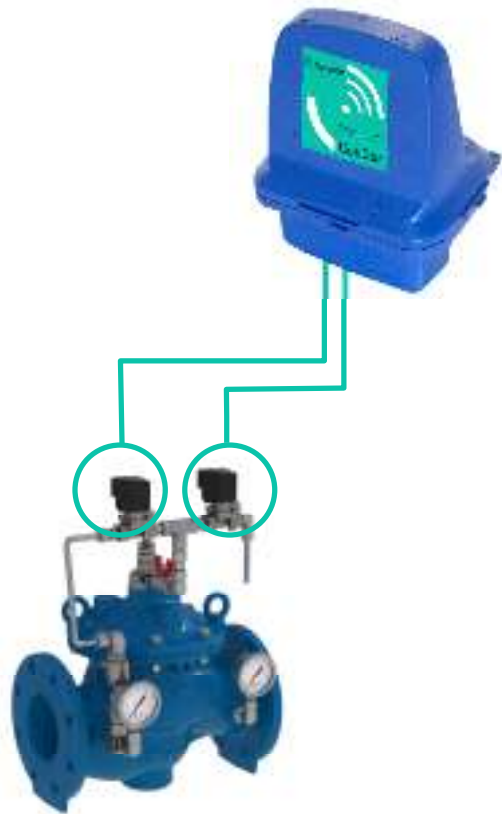

4G

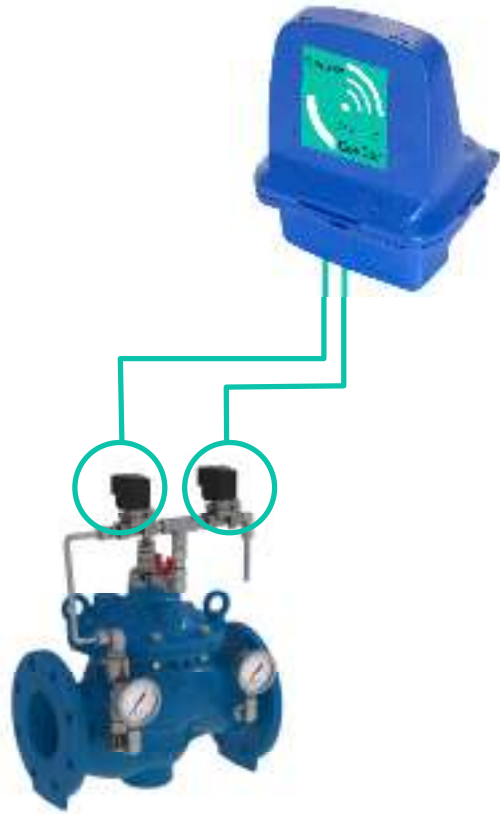

Enkel styring og overvåkning

- Trykkstyring
- Mengdestyring
- Oppsett av sensorer
- Avlesning av trykk
- Avlesning av mengde
- Åpningsgrad



The screenshot shows a mobile application interface titled "New Sensor". The form contains the following fields and values:

Name	
Flow rate	

Port	
AN1	

Unit Name	
Liter	

Per Time Unit	
Sec	

Min Value Ref.	Min Value Gives
0 mA	0 liter

Max Value Ref.	Max Value Gives
20 mA	50 liter

BRANNSIKKERHET



| Kan raskt og enkelt øke vannforsyning ved brann



Brann og sikkerhet

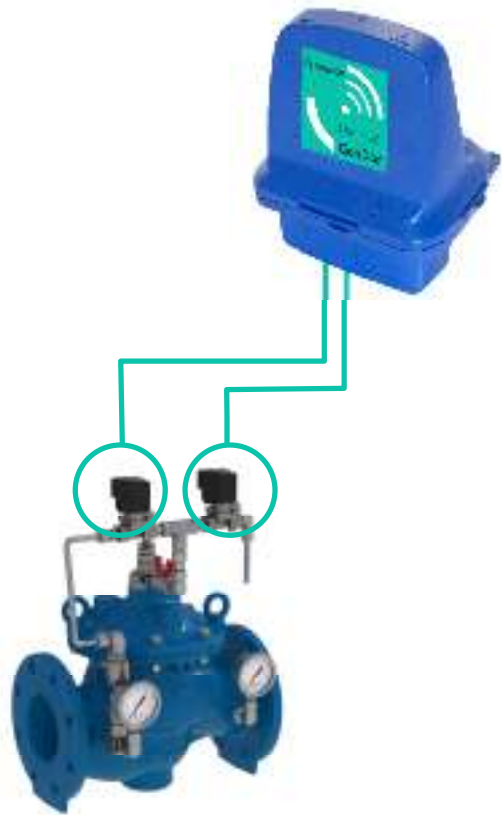

4G



EFFEKTIVT OG ØKONOMISK



Vannet kan enkelt og raskt stoppes ved ledningsbrudd



Effektivt og økonomisk



- **Kan raskt og enkelt stoppe vannet ved ledningsbrudd**

SPØRSMÅL?

